

Manufacturer's Data and Design Characteristics							
Characteristics							
1.01	Manufacturer		HELI				
1.02	Model		CBD15J-Li3	CBD18J-Li3	CBD20J-Li3		
1.03	Power unit		Electric	Electric	Electric		
1.04	Operation		Pedestrian	Pedestrian	Pedestrian		
1.05	Rated traction weight	Q (t)	1.5	1.8	2.0		
1.06	Load centre	c (mm)	600	600	600		
1.07	Axle centre to fork face	x (mm)	944	944	944		
1.08	Wheel base	y (mm)	1190	1190	1190		
Weights							
2.01	Service weight with battery	kg	138	148	150		
Wheels/Tyres							
3.01	Wheels type		Polyurethane	Polyurethane	Polyurethane		
3.02	Driving wheel size	Φ×w(mm)	Φ210×70	Φ210×70	Φ210×70		
3.03	Bearing wheel size	Φ×w(mm)	Φ80×60	Φ80×60	Φ80×60		
3.04	Wheels, number front/rear (x = driven)		1x/4	1x/4	1x/4		
3.05	Track width	b11 (mm)	400/535	400/535	400/535		
Dimensions							
4.01	Lift	h3 (mm)	200	200	200		
4.02	Overall height(With handle)	h14 (mm)	725/1145	725/1145	725/1145		
4.03	Lowered height	h13 (mm)	85	85	85		
4.04	Overall length	l1 (mm)	1550	1550	1550		
4.05	Length to fork face	l2 (mm)	400	400	400		
4.06	Overall width	b1/ b2 (mm)	550/685	550/685	550/685		
4.07	Fork dimensions	s/e/l (mm)	50/150/1150	50/150/1150	50/150/1150		
4.08	Width of forks	b5 (mm)	550/685	550/685	550/685		
4.09	Min.Ground clearance	m2 (mm)	35	35	35		
4.10	Aisle width with pallet 1000 x 1200 across forks	Ast (mm)	1750	1750	1750		
4.11	Aisle width with pallet 800 x 1200 along forks	Ast (mm)	1800	1800	1800		
4.12	Min.Turning radius	Wa (mm)	1345	1345	1345		
Performance							
5.01	Travel speed,laden/unladen	(km/h)	4.2/4.5	4.2/4.5	4.2/4.5		
5.02	Maximum climbing ability, with/without load	(%)	5/10	5/10	5/10		
5.03	Service brake		Electromagnetic brake	Electromagnetic brake	Electromagnetic brake		
Drive							
6.01	Drive motor, 60 minute rating	(kW)	0.75	0.75	0.75		
6.02	Lift motor rating at S3 15%	(kW)	0.8	0.8	0.8		
6.03	Battery according to DIN 43531/35/36 A,B,C,no		no	no	no		
6.04	Battery voltage/rated capacity	(V/Ah)	24/20	24/30	24/40	48/15	48/20
6.05	Battery weight (± 5%)	(kg)	5.5	7	8.2	7	8.2
7.01	Type of drive control		DC	DC	DC		
7.02	Noise level at operator's ear	(dB(A))	≤70	≤70	≤70		
7.03	Steering type		Mechanical steering	Mechanical steering	Mechanical steering		
7.04	Controller brand		Curtis	Curtis	Curtis		

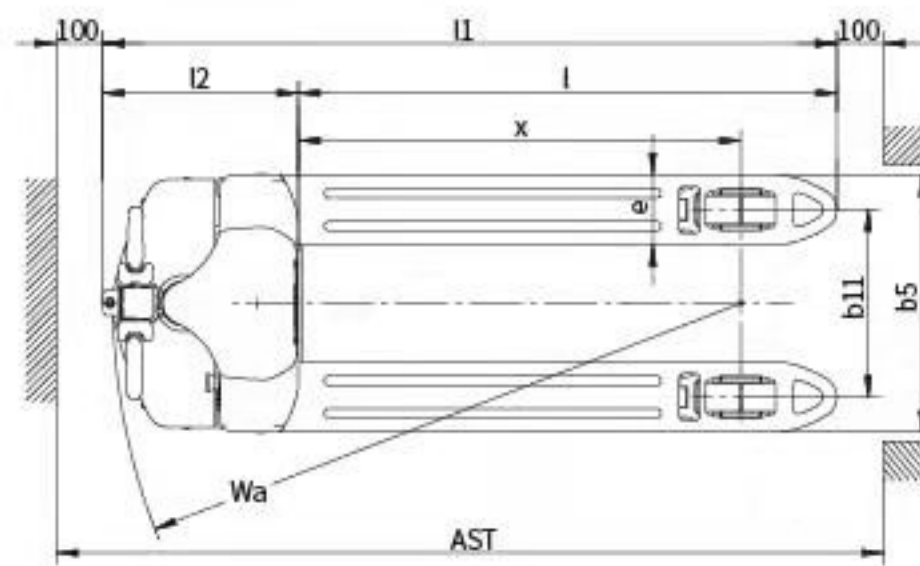

CBD15J/18J/20J-Li3

The 3rd Generation Lithium Battery Pallet Truck

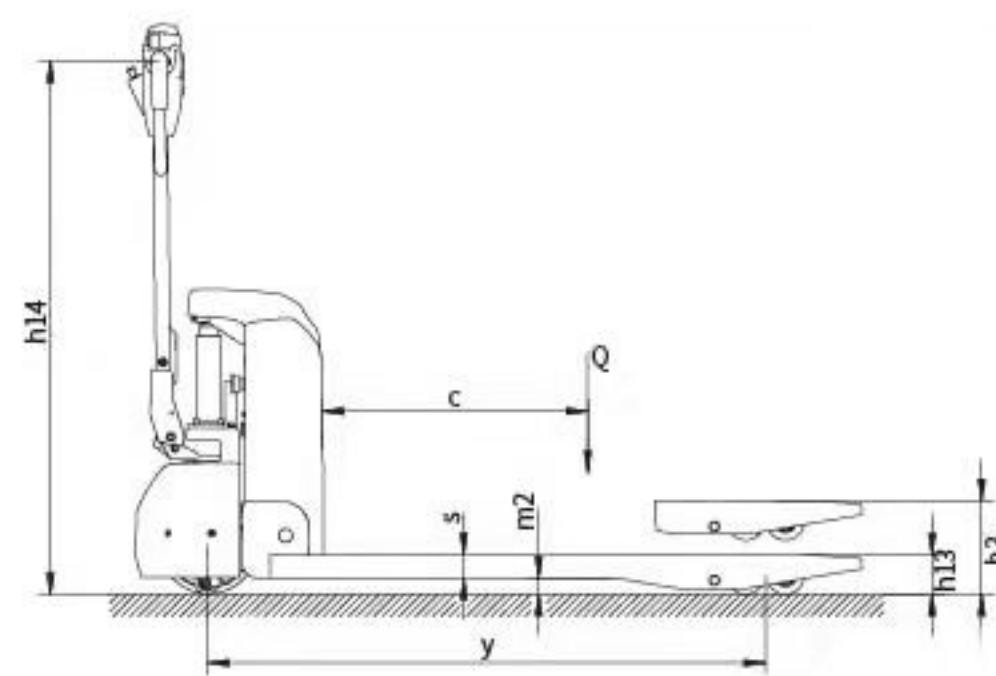

ANHUI HELI CO., LTD.

Add / No.668, FangXing Road, Hefei, China
 Fax / +86-551-63639966
 Tel / +86-551-63639068(America); 63639258(Europe); 63639358(Asia);
 63662105(Africa & Middle East); 63639530(Overseas Marketing)



LinkedIn



YouTube



Facebook

Design&Print:Fokell Printing 20220407







EMPOWER THE WORLD

www.heliforklift.net

* Our products are subject to improvements and changes without notice.

1 EASY TO MAINTENANCE



-  **Lithium battery, maintenance free**
-  **Brushless drive motor, maintenance free**
-  **5s Replace Battery**
-  **Error code display**
-  **Perfect after-sales and accessory services**
-  **Built-out charger is standard**

2 PERFORMANCE



Traveling speed

UNLADEN	4.5Km/h
LADEN	4.2Km/h

Gradeability

Without load **10%**











With load **5%**



3 CHARACTERISTICS

closer look into



-  **Built-in Charger (Optional)**
-  **Built-out Charger**
-  **Concave Design**
-  **Integral Forks**
-  **PU Wheel**
-  **Smart Handle (Optional)**
-  **Normal Handle**
-  **Battery Protection Stopper**
-  **Electric Lifting/Lowering**
-  **Protection Cover**